

# Table of Contents

2	<b>Replacement Electrodes</b>
2	Autochlor™ Electrodes / AC Series
2	Autochlor™ Electrodes / RP Series
3	Autochlor™ Electrodes / SM Series
3	Autochlor™ SM Electrodes / SR/SA Series
3	Autochlor™ SMCWM Reverse Polarity (Reduced Maintenance) Electrodes / SMCWM Series
3	Autochlor™ SMC Reverse Polarity (Reduced Maintenance) Electrodes / SRC/SAC Series
4	Ecoline™ FSMC Reverse Polarity (Reduced Maintenance) Electrodes / FSRC/MFSRC Series
5~8	<b>Spare Parts</b> Models With The Output Under 100gr/h
9~16	<b>Spare Parts</b> Models With The Output Above 100gr/h

# Replacement Electrodes

## AUTOCHLOR™ ELECTRODES / AC SERIES

Machine Type	Picture	Ordering Code	Description
AC Spa/Mini		SPADTLPO	To Suit AC-SPA ~ (1 x 5 Amp. 140 x 60mm 3 Plate Electrode Included In Pack)
AC15		ECELDTLPO	To Suit AC15 ~ (1 x 15 Amp. 140 x 60mm 5 Plate Electrode Included In Pack)
AC20		KCELDTLPO	To Suit AC20 ~ (1 x 20 Amp. 115 x 60mm 7 Plate Electrode Included In Pack)
AC25		SCELDTLPO	To Suit AC25 ~ (1 x 25 Amp. 140 x 60mm 7 Plate Electrode Included In Pack)
AC35		PCELDTLPO	To Suit AC35 ~ (1 x 35 Amp. 195 x 60mm 7 Plate Electrode Included In Pack)
AC50		FCELDSTLPO	To Suit AC50 (1 x 50 Amp. 270 x 60mm 7 Plate Electrode Included In Pack)
AC50HD		FCELDCTLPO	To Suit AC50HD (1 x 50 Amp. 270 x 60mm 7 Plate Heavy Duty Electrode Included In Pack)
AC100HD		2 X FCELDCTLPO	To Suit AC100HD (2 x 50 Amp. 270 x 60mm 7 Plate Heavy Duty Electrodes Included In Pack)

## AUTOCHLOR™ ELECTRODES / RP SERIES



RP7		CELLRP7T	To Suit RP7
RP15		CELLRP15T	To Suit RP15 ~ (1 x 15 Amp. 140 x 60mm 5 Plate Electrode Included In Pack)
RP20		CELLRP20T	To Suit RP20 ~ (1 x 20 Amp. 115 x 60mm 7 Plate Electrode Included In Pack)
RP25		CELLRP25T	To Suit RP25 ~ (1 x 25 Amp. 140 x 60mm 7 Plate Electrode Included In Pack)
RP25		CELLRP25T:13 PLATE	To Suit RP25 ~ (1 x 13 Amp. 115 x 60mm 13 Plate Bi-Polar Electrode Included In Pack)
RP35		CELLRP35T	To Suit RP25 ~ (1 x 35 Amp. 195 x 60mm 7 Plate Electrode Included In Pack)
RP36		CELLRP36T	To Suit RP36 ~ (1 x 20 Amp. 140 x 60mm 13 Plate Bi-Polar Electrode Included In Pack)
RP64		CELLRP64T	To Suit RP64 ~ (1 x 35 Amp. 220 x 60mm 13 Plate Bi-Polar Electrode Included In Pack)
RP92		CELLRP100T	To Suit RP92 ~ (1 x 50 Amp. 270 x 60mm 13 Plate Bi-Polar Electrode Included In Pack)

NB: The AC and RP series of electrodes can be ordered with bayonet caps, with wing nut connectors, with standard or heavy-duty terminals. Heavy-duty grade electrodes for the AC/RP models can be priced on application.





NB: The lengths of the CELLRP25T, CELLRP20T, and CELLRP15T cells have been reduced. When supplying replacement electrodes to customers, please provide new electrode types. They are configured to operate with existing power supplies.

# Replacement Electrodes



## AUTOCHLOR™ ELECTRODESS / SM SERIES

Machine Type	Picture	Ordering Code	Description
SM20		CELLSMC20	To Suit SM20 ~ (5 Amp. 170 x 60mm 7 Plate Bi-Polar Electrode Included In Pack)
SM30		CELLSMC30	To Suit SM30 ~ (7Amp. 170 x 60mm 13 Plate Bi-Polar Electrode Included In Pack)

## AUTOCHLOR™ SM ELECTRODES/SR/SA SERIES

Ordering Code	Picture	Description
CELLSM200		To Suit SR-200 Electrolyser/Chlorine Generator
CELLSM300		To Suit SR-300 Electrolyser/Chlorine Generator
CELLSM400		To Suit SR-400, SA-800, SA-1600 Electrolysers/Chlorine Generators
CELLSM500		To Suit SR-500, SA-1000, SA-2000, SA-3000 Electrolysers/Chlorine Generators

## AUTOCHLOR™ SMCWM REVERSE POLARITY (REDUCED MAINTENANCE) ELECTRODES/SMCWM SERIES

CELLSMC50		To Suit SMCWM-100 Electrolyser/Chlorine Generator
CELLSMC40		To Suit SMCWM-150 Electrolyser/Chlorine Generator

## AUTOCHLOR™ SMC REVERSE POLARITY (REDUCED MAINTENANCE) ELECTRODES/SRC/SAC SERIES

CELLSMC100		To Suit SRC-100 Electrolyser/Chlorine Generator
CELLSMC150		To Suit SRC-150 Electrolyser/Chlorine Generator
CELLSMC200		To Suit SRC-200 Electrolyser/Chlorine Generator
CELLSMC300		To Suit SRC-300 Electrolyser/Chlorine Generator
CELLSMC400		To Suit SRC-400, SAC-800 Electrolysers/Chlorine Generators
CELLSMC500		To Suit SRC-500, SAC-1000, SAC-2000 Electrolysers/Chlorine Generators
CELLSMC625		To Suit SAC-625, SAC-1250, SAC-2500 Electrolysers/Chlorine Generators
CELLSMC750		To Suit SAC-1500, SAC-3000 Electrolysers/Chlorine Generators
CELLSMC800		To suit SRC-800 Electrolyser/Chlorine Generator
CELLSMC1500		To Suit SRC-1500 Electrolyser/Chlorine Generator

NB: Please note that ordering codes refer to one cell only. If your chlorine generator requires more than one cell be sure to order the correct quantity.

# Replacement Electrodes

## ECOLINE™ FSMC REVERSE POLARITY (REDUCED MAINTENANCE) ELECTRODES/FSRC/MFSRC SERIES

CELLFSMC50		To Suit FSRC-50, MFSRC-50 Electrolysers/Chlorine Generators
CELLFSMC75		To Suit FSRC-75, MFSRC-75 Electrolysers/Chlorine Generators
CELLFSMC100		To Suit FSRC-100, MFSRC-100 Electrolysers/Chlorine Generators
CELLFSMC150		To Suit FSRC-150, MFSRC-150 Electrolysers/Chlorine Generators
CELLFSMC200		To Suit FSRC-200, MFSRC-200 Electrolysers/Chlorine Generators
CELLFSMC250		To Suit FSRC-250, MFSRC-250, FSRC-500 Electrolysers/Chlorine Generators
CELLFSMC300		To Suit FSRC-300, MFSRC-300 Electrolysers/Chlorine Generators
CELLFSMC400		To Suit FSRC-400 Electrolyser/Chlorine Generator
CELLFSMC425		To Suit FSRC-425, MFSRC-425, FSRC-850, FSRC-1275, FSRC-1700 Electrolysers/Chlorine Generators

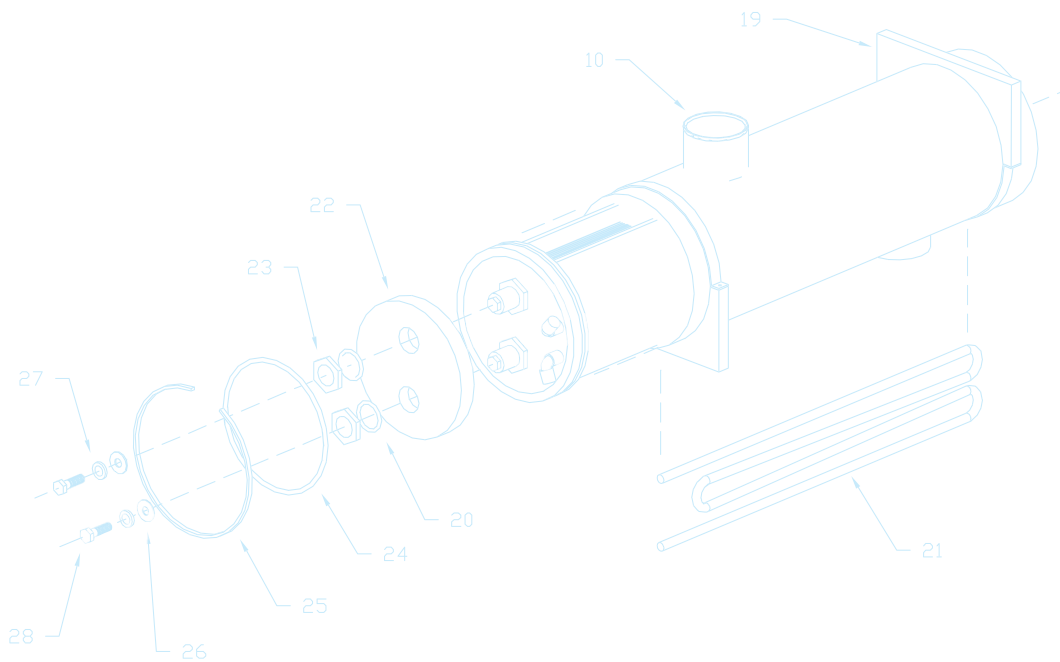

NB: Please note that ordering codes refer to one electrode only. If your Electrolyser/Chlorine Generator requires more than one electrode be sure to order the correct quantity.

# Spare Parts

MODELS WITH THE OUTPUT UNDER 100GR/H

Ordering Code	Picture	Description
AEPOT		Potentiometer 10k (For PCB) 3310p-001-103 Bourns
BR		Bridge Rectifier 50 Amp FB5006 (Fagor)
CAPBAY		Cap Bayonet Twistlock Electrode
CAPTH		Cap Threadlock Electrode With Sensor Pin And O-Ring, Grey
CAPUNI		Cap Bayonet Uni Electrode Yellow (Bare)
CB3		Circuit Breaker 3 Amp
CB5		Circuit Breaker 5 Amp
CB15		Circuit Breaker 15 Amp
CBBS006		O-Ring BS008 3/16"Idx1/16" Thick Nitrile (For SM Electrodes)
CGL		Cord Grip Bushing Large
CGS		Cord Grip Bushing Small
CHPOM		Electrode Hardware Male (+/-) Push On Brass Connectors
CHPOMHD		Electrode Hardware Female (+/-) Heavy Duty Push On Brass Connectors
CHTL		Housing Threadlock Electrode Large Clear
CHTM		Housing Threadlock Electrode Medium Clear
CHTS		Housing Threadlock Electrode Small Clear
CL25POC		Electrode Lead 25 Amp With Push On Connectors (Suits 15, 20 & 25 Amp)
CL50POC		Electrode Lead 50 Amp With Heavy Duty Push On Connectors
CLSMC		Electrode Lead SMC Electrolyser/Chlorine Generator Blue

# Spare Parts

MODELS WITH THE OUTPUT UNDER 100GR/H

Ordering Code	Picture	Description
CS		Spacer 7 Blade Electrode AC Series (2 Pieces Per Set)
DIMMER		Dimmer Control Fan/Light 230-240VAC 50Hz
DIO4004		Diode 1N4004 1 Amp 400V Axial (5,000 Reel)
DIODE		Diode 40HF60 Cathode Stud 600V 40A
FCL		Front Cover Large Polycarbonate 3mm Solar Grey
FCS		Front Cover Small Polycarbonate 3mm Solar Grey
KNOB		Knob PCB Control
L240		Lead And 3 Pin Plug 240 Volt 3 Core Flex Black (2 Mtr Long)
LEADKIT		Electrode Lead Conversion Kit Push On Connectors (+/-) & Sensor 25 Amp
LEADKITHD		Lead Kit Heavy Duty 50 Amp
LR		Ring Locking Threadlock Electrode Housing Grey
METER15		Meter 15 Amp Salt Monitor
METER20		Meter 20 Amp Salt Monitor
METER30		Meter 30 Amp Salt Monitor
METER50		Meter 0 - 50 Amp Graduations
NH		Hinge Nylon (Male & Female) Pair RA250W
OR1/4		O-Ring 1/4" Electrode Bolt BS010
OR5/16		O-Ring 5/16" Electrode Bolt BS011
ORTLC		O-Ring Threadlock Housing S50 Grey (99.6x88.5x3.5mm)













# Spare Parts

MODELS WITH THE OUTPUT UNDER 100GR/H

Ordering Code	Picture	Description
ORUNI		O-Ring Uni Cap S45 Yellow (91.5x84.4x3.5mm)
PCB		Board AC Series Electrolyser/Chlorine Generator Programmed Complete
PCBRP		Board RP Series Reverse Polarity Electrolyser/Chlorine Generator Programmed
PO		Socket 240 Volt Pump Outlet
SCR		SCR Non Insulated "W" (Flat Pack)
SCRI		SCR Insulated "J" (Flat Pack)
SL		Sensor Lead Repair Kit (255mm Long) Black
SWP2		Switch 2 Way Panel Mt 240 Volt
SWP3		Switch 3 Way Panel Mt 240 Volt
SWR2		Switch 2 Way Rocker 240 Volt
SWR3		Switch 3 Way Rocker 240 Volt
TC		Time Clock Grasslin (Black & White Face) (24hr Model)
TCELCD		Time Clock Electronic Lcd Display (SMC Electrolyser/Chlorine Generator)
TCI		Time Clock Grasslin W/Override
TCM		Time Clock Matsushita A-TB72 Without Backup
TCMP		Mounting Plate Graslin Timer
TCQ		Time Clock Grasslin Quartz
TCUNI		Time Clock Grasslin Uni 45



# Spare Parts

MODELS WITH THE OUTPUT UNDER 100GR/H

Ordering Code	Picture	Description
TPSMCB		Board Switch Mode Controller
TPSMPSB		Board Switch Mode Power Supply
TXAC15/240		Transformer AC-15 240 Volt 15 Amp
TXAC20/240		Transformer AC-20 240 Volt 20 Amp
TXAC25/240		Transformer AC-25 240 Volt 25 Amp
TXAC35/240		Transformer AC-35 240 Volt 35 Amp
TXAC50/240		Transformer AC-50 240 Volt 50 Amp
TXAC100/240		Transformer AC-100 240 Volt 100 Amp
TXPL12		Transformer Pool Light 12V/150W
TXPL24		Transformer Pool Light 24V/150W
TXPL32		Transformer Pool Light 32V/150W
TXPL350VA		Transformer Toroidal Pool Light 240V Input/175VA 25A Output
TXRP15/240		Transformer RP-15 240 Volt 15 Amp
TXRP20/240		Transformer RP-20 240 Volt 20 Amp
TXRP25/240		Transformer RP-25 240 Volt 25 Amp
TXRP35/240		Transformer RP-35 240 Volt 35 Amp
TXRP50/240		Transformer RP-50 240 Volt 50 Amp



# Spare Parts

MODELS WITH THE OUTPUT ABOVE 100GR/H

Ordering Code	Picture	Description
106SV-1/2		Titanium Relief Valve 1/2" BSP
106SV-3/4		Titanium Relief Valve 3/4" BSP
ACCH150		Electrode Cap For 150mm Housing
ACCH200		Electrode Cap For 200mm Housing
AECH150		End Cap For 150mm Housing
AECH200		End Cap For 200mm Housing
AUXCON		Auxiliary Contact, Miniature Circuit Breaker
CBBS216		Electrode Bolt O-Ring (e.g. CELLSMC200, CELLSMC300)
CBBS224		Electrode Bolt O-Ring (from CELLSMC400 And Above)
CBBS434		Electrode Cap O-Ring For 150mm Housing
CBBS443		Electrode Cap O-Ring For 200mm Housing
CFOURCH200		Four-Electrodes Housing 200mm
CFOURCH200P		Four-Electrodes Housing 200mm P-1600
CJX2-115-4		Contactor For SRC-200
CJX2-150-4		Contactor For SRC-300
CJX2-225-4		Contactor For SRC-400
CJX2-265-4		Contactor For SRC-500
CJX2-63-4		Contactor For SMCWM-150

# Spare Parts

MODELS WITH THE OUTPUT ABOVE 100GR/H

Ordering Code	Picture	Description
CJX2-95-4		Contactor For SMCWM-100
CJX2-F400-4		LC1-F4004; 4 Pole Contactor With 240V Coil
CJX2-F500-4		Contactor For SAC-3000
CLR150		Electrode Lock Ring For 150mm Housing
CLR200		Electrode Lock Ring For 200mm Housing
COOLING H200/300		Cooling Reservoir Clear Housing 50mm SRC-200/300
COOLING H400/500		Cooling Reservoir Clear Housing 50mm SRC-400/500
COOLING R200/300		Cooling Reservoir 50mm SRC-200/300
COOLING R400/500		Cooling Reservoir 50mm SRC-400/500
COOLING.G		Cooling Reservoir Gate
COOLING.IN		Cooling Reservoir Threaded Brass Inlet 12mm Outside Diameter By 1/4" NPT18 Thread
COOLING.L		Cooling Reservoir Lid
CSCH150		Single Electrode Housing 150mm
CSCH200		Single Electrode Housing 200mm
CSCHM200		Single Electrode Housing Modular 200mm
CTWOCH200		Two-Electrodes housing 200mm
DUCT.FITTING		Ducting Fitting, 100mm
DUCT.FITTING.FAN		Ducting Fitting With Fan, 100mm

# Spare Parts

MODELS WITH THE OUTPUT ABOVE 100GR/H

Ordering Code	Picture	Description
FAN10220		Thermal Protected Fan Blade 10" 240V/50Hz
FAN120BB240V		Cooling Fan, 120mm, Ball-bearing, 240VAC
GUARD10220		Fan Finger Guard Metal Chrome Plated Size: 254mm For FAN10220
HAGNT105C		Circuit Breaker 6A Single Phase, D-Type
HAGNT105C.3P		Circuit Breaker 6A Three Phase, D-Type
HAGNT110C		Circuit Breaker 10A Single Phase, D-Type
HAGNT110C.3P		Circuit Breaker 10A Three Phase, D-Type
HAGNT116C		Circuit Breaker 16A Single Phase, D-Type
HAGNT116C.3P		Circuit Breaker 16A Three Phase, D-Type
HAGNT120C		Circuit Breaker 20A Single Phase, D-Type
HAGNT120C.3P		Circuit Breaker 20A Three Phase, D-Type
HAGNT132C		Circuit Breaker 32A Single Phase, D-Type
HAGNT132C.3P		Circuit Breaker 32A Three Phase, D-Type
HDR-120-12		Din-Rail Mounted 12VDC 10A Power Supply With Thermo-Regulator
HWFSWQ12		Flow Switch
IEC0.5TWSCR		Cable Two Core 0.5mm Twisted, Screened
IPMD100RT		Magnetic Acid Pump MD100
IPMD6RT		Magnetic Acid pump MD6
IPMD10RT		Magnetic Acid pump MD10
IPMD15RT		Magnetic Acid pump MD15

# Spare Parts

MODELS WITH THE OUTPUT ABOVE 100GR/H

Ordering Code	Picture	Description
IPMD20RT		Magnetic Acid pump MD20
IPMD30RT		Magnetic Acid pump MD30
IPMD40RT		Magnetic Acid Pump MD40
IPMD55RT		Magnetic Acid Pump MD55
IPMD70RT		Magnetic Acid Pump MD70
K8ABPW2		Measuring And Monitoring Relay, Three Phase
K8ABVW3		Measuring And Monitoring Relay, Single Phase
L-801		Cooling Pump For SRC200/SRC-300
LCD.SG12864A		LCD Display For SM Electrolyser/Chlorine Generator Ver 3.0 And Ver 5.3
MF-63-4		SMPS Sequential Contactor
PARTS.SPECIAL		SMPS Sub-Board For 2K4S Series
PARTS.SPECIAL		SMPS Sub-Board 1K2U Series
PARTS.SPECIAL		SMPS Sub-Board With Terminal For 1K2U Series
PARTS.SPECIAL		SMPS Sub-Board 66-B574-2100; 66-B575-1100
PCLTSMC200/300		Acid Tank For SMC-200/SMC-300
PCLTSMC3000		Acid Tank For SAC-3000
PCLTSMC400/500		Acid Tank For SRC-400/SRC-500
PCLTSMC750/1000		Acid Tank For SAC-800/SAC-1000
PCLTSRC200/300		Acid Tank For SRC-200/SRC-300

# Spare Parts

MODELS WITH THE OUTPUT ABOVE 100GR/H

Ordering Code	Picture	Description
PIC18F458-I/P		Microchip PIC18F458-I/P Unprogrammed
QF1/2SW		Spring Washer For Electrode Connectors (e.g. CELLSMC200, CELLSMC300)
QF12112BB		Brass Bolt For Electrode Connectors (e.g. CELLSMC200, CELLSMC300)
QF12118		Brass Washer For Electrode Connectors (e.g. CELLSMC200, CELLSMC300)
QF5813BW		Brass Washer For Electrode Connectors (From CELLSMC400 And Above)
QF58BHS		Brass Bolt For Electrode Connectors (From CELLSMC400 And Above)
QF58SW		Spring Washer For Electrode Connectors (From CELLSMC400 And Above)
QFM1-1/8BN		Brass Nut, 1-1/8 UNF 14 TPI, 9mm Thick
QFM1-3/4BN		Brass Nut, 1-3/4 UNF 12 TPI, 10mm Thick
RADIATOR		Radiator For SRC-200/SRC-300
RELF55.34		External Control Relay 5A, 240V
SCP1200-05-200		Switchmode Power Supply 1K2-Series
SCP1200-06-166U		Switchmode Power Supply 1K2-Series
SCP1200-09-133		Switchmode Power Supply 1K2-Series
SCP1200-12-100		Switchmode Power Supply 1K2-Series
SCP1200-12-100U		Switchmode Power Supply 1K2-Series
SCP1200-15-80U		Switchmode Power Supply 1K2-Series
SCP1200-18-66		Switchmode Power Supply 1K2-Series

# Spare Parts

MODELS WITH THE OUTPUT ABOVE 100GR/H

Ordering Code	Picture	Description
SCP1200-24-50		Switchmode Power Supply 1K2-Series
SCP1200-24-50U		Switchmode Power Supply 1K2-Series
SCP1500-08-150		Switchmode Power Supply 1K5-Series
SCP1500-12-125U		Switchmode Power Supply 1K5-Series
SCP1500-18-83		Switchmode Power Supply 1K5-Series
SCP1500-24-62		Switchmode Power Supply 1K5-Series
SCP1500-24-62U		Switchmode Power Supply 1K5-Series
SCP2400-06-300		Switchmode Power Supply 2K4-Series
SCP2400-09-266		Switchmode Power Supply 2K4-Series
SCP2400-12-200		Switchmode Power Supply 2K4-Series
SCP2400-24-100		Switchmode Power Supply 2K4-Series
SCP600-05-80U		Switchmode Power Supply 600-Series
SCP600-12-50U		Switchmode Power Supply 600-Series
SCP600-15-40U		Switchmode Power Supply 600-Series
SCP600-18-33U		Switchmode Power Supply 600-Series
SCP600-24-25		Switchmode Power Supply 600-Series
SCP600-24-25U		Switchmode Power Supply 600-Series
SCP800-09-88		Switchmode Power Supply 800-Series

# Spare Parts

MODELS WITH THE OUTPUT ABOVE 100GR/H

Ordering Code	Picture	Description
SCP800-12-66		Switchmode Power Supply 800-Series
SD512		1GB Secure Digital (SD) Card
SE1TUB		Valve 1" (25mm) (e.g. Acid-Wash Valves)
SE2TUB		Valve 2" (e.g. M1 & M2 Valves On SRC-200/SRC-300)
SE3/4TUB		Valve 3/4" (e.g. Acid-Wash Valves)
SE3TUB		Valve 3" (e.g. M1 & M2 Valves On SRC-400 And Above)
SHUNT100A100		Shunt For SMCWM100 (100A, 100mV)
SHUNT300A100		Shunt For SRC-200 (300A, 100mV)
SHUNT400A100		Shunt For SRC-300 (400A, 100mV)
SHUNT50A100		Shunt For SMCWM150 (50A, 100mV)
SHUNT600A100		Shunt For SRC-400 (600A, 100mV)
SHUNT800A100		Shunt For SRC-500 And Above (800A, 100mV)
SMCCBV5.1		Control Board Ver 5.1
SMCCBV5.3		Control Board Ver 5.3
SMCFSV1.0E		Keypad For Ver 1.0/Ver 5.1
SMCFSV3.0E		Keypad For Ver 3.0/Ver 5.3
SOCF94.04		External Control Socket For Relay 5A, 240V
SPC12-04		Cooling Reservoir Threaded Brass Push-On Outlet, 12mm

# Spare Parts

MODELS WITH THE OUTPUT ABOVE 100GR/H

Ordering Code	Picture	Description
SPDEV		Surge Protection Device
SPE-12		Tee Compression 12mm 90DEG PU
SPV-12		Cooling Reservoir Plastic Elbow Push-On, 12mm
STDEL10		Timing Relay 0.1s~10 Seconds Delay Start AC 230: 5A, DC30: 1A
STDEL120		Timing Relay 10~120 Seconds Delay Start AC 230: 5A, DC30: 1A
THE.ADR		Titanium Heat Exchanger Threated Brass Inlet/Outlet Adaptor 12mm Outside Diameter By 5/8'' - 18 UNF Thread
THE.M.10MMMOD		Titanium Heat Exchanger For SRC-200/SRC-300
THERM.NTC		Temperature Sensor In Titanium Housing
THERM.NTC.10		Thermistor, R/T, NTC, 10k, 25degC
THERM.NTC.5		Thermistor, R/T, NTC, 5k, 25degC
PHPROBE		PH Probe For Commercial PH Controller Board Ver2.1
PHCBV2.1		Commercial PH Controller Board Ver2.1
DOSPUMP		Dosing Pump